

# Name the Instrument Level 2 sheet 1

From the picture clues names the instrument, then transpose the circled letter to the answer space. This will be the answer to the music trivia question:

**What rock band had 2 left-handed members?**

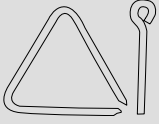

1 \_\_\_\_\_

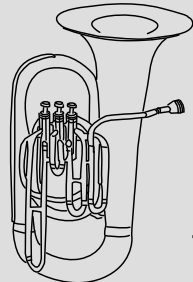

\_\_\_\_\_ 6

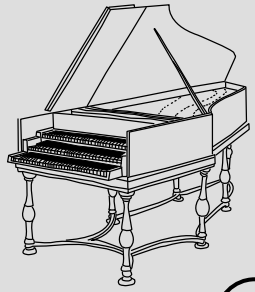

\_\_\_\_\_ 2

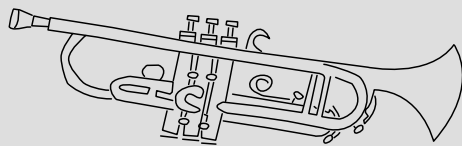

\_\_\_\_\_ 7

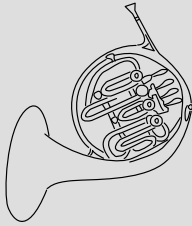

\_\_\_\_\_ 3

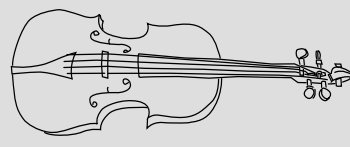

\_\_\_\_\_ 8

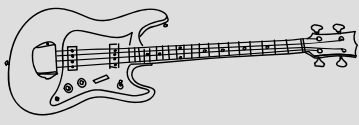

4 \_\_\_\_\_

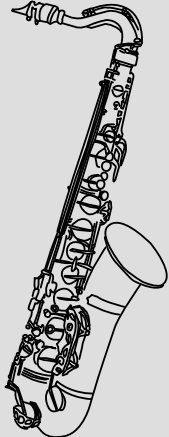

10 \_\_\_\_\_ 9

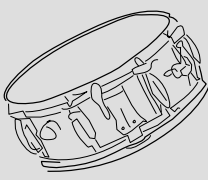

\_\_\_\_\_ 5

**What rock band had 2 left-handed members?**

1 2 3 4 5 6 7 8 9 10