

Name the Instrument Level 2 sheet 1

From the picture clues names the instrument, then transpose the circled letter to the answer space. This will be the answer to the music trivia question:

What rock band had 2 left-handed members?

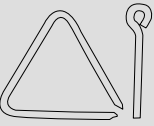

1 _____

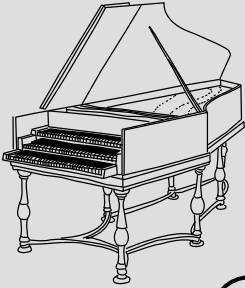

2 _____

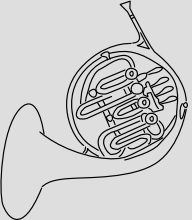

3 _____

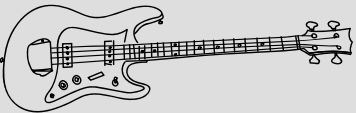

4 _____

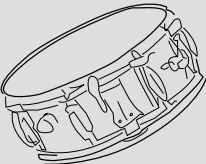

5 _____

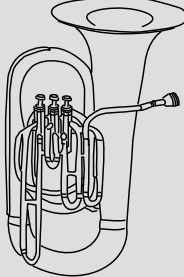

6 _____

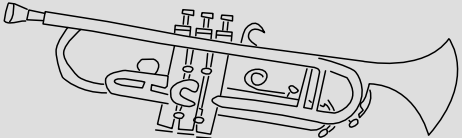

7 _____

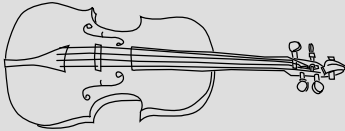

8 _____



10 _____ 9 _____

What rock band had 2 left-handed members?

1 2 3 4 5 6 7 8 9 10